

# KENWOOD

## ProTalk<sup>®</sup>FD

NO LICENSE REQUIRED

### WD-K10 Series

DECT Intercom System



# K10

Digital communication  
for 10 people

**Simple, full-duplex hands-free operation.  
Up to 10 people can talk simultaneously.**

# Easy-to-use, advanced Digital Wireless Intercom System

## DECT Intercom System WD-K10 Series

The WD-K10 Series is KENWOOD's DECT Intercom System, offering simple, full-duplex hands-free, simultaneous two-way communications. It can significantly ease day-to-day operations with conversational staff contact & coordination anytime, anywhere – indoors and outdoors.



**K10**  
Digital communication  
for 10 people



### Enjoy HANDS-FREE operation!

- IMMEDIATELY convey instructions to staff.
- Exchange information in REAL-TIME.
- Communicate EFFICIENTLY with the team.



Ideal for crane operators, railroad maintenance, manufacturing, casinos & entertainment complexes, drive-throughs, etc.

## Advanced & Convenient

Compact, lightweight and simple to use – indoors or outdoors

Small and light, these transceivers are tough and simple to use



**WD-K10TR**  
TRANSCIVER

**WD-K10PBS**  
PORTABLE BASE

### ■ WD-K10TR and WD-K10PBS – Both compact yet offer long talk time

Just 20mm in depth and the size of a business card, the WD-K10TR transceiver is amazingly small and light (118g), making it easy to work with all day long. Despite its compact design, it can operate on a single battery charge for up to 20 hours.

The WD-K10PBS (135g) can be used as a portable base station or transceiver. In Portable Base mode, it operates for up to 8 hours while communicating with up to 4 transceivers. In Transceiver mode, it operates for up to 25 hours.

### ■ Superior digital technology ensures clear communications

Digital communication supports high-quality audio, which means that messages and instructions are relayed clearly. Since this DECT system operates at 1.9GHz, this intercom system will work side by side with wireless LAN equipment, which operate at 2.4GHz or 5GHz.

## ■ Rugged construction for dustproof/waterproof performance

Offering IP67-equivalent\* levels of dustproofing and waterproofing, these tough units can be used with confidence around water and at outdoor events, even in poor weather conditions. If the units have become dirty with mud, they can be rinsed clean (within the limits of IP67-equivalent protection). Both units meet or exceed US MIL-STD 810C through G in 11 categories.

\* Dust- and water-proofing levels apply only for the transceivers, and not for the accessories.



Note: Check to see the transmissible ranges prior to using the transceivers.

## ■ Portable base station for use just about anywhere

When a group is working outside, at a construction site or outdoor event for example, it is often not possible to install a fixed base station. There may even not be an AC power supply available. Ideal for such situations is the WD-K10PBS portable base, which can function as a transceiver as well. Using an optional cable, the WD-K10PBS can be connected to a compatible KENWOOD two-way radio, which will act as a bridge between two geographically separated intercom systems.



## ■ Designed throughout for ease of use and convenience

- Up to 64 transceivers can be used in Listening Mode
- High-quality Audio Mode for greater clarity
- Group LED displays the current communication group
- Function button for instant selection of a frequently used function.
- Volume Attenuation to temporarily reduce volume when talking to a customer
- Voice Announcement of current settings
- Remaining battery capacity indicated by blinking LED and Voice Announcement
- Key Lock to protect from accidental operation

Featuring audio-in/out terminals, the WD-K10BS base station can also be used outdoors.

## ■ Simple stand-alone system (base station + transceivers)

The WD-K10BS base station is the core of this system – an ideal choice for initial adoption. Up to 10 transceivers can join in simultaneous two-way conversations.

## ■ Coverage expansion possible (Base-link system)

You can daisy-chain up to 4 x WD-K10BS base stations to extend the communication area (Note: no more than to 10 transceivers can engage in a simultaneous two-way conversation).



**WD-K10BS**  
BASE STATION

## ■ Audio in/out terminals for use with broadcasting equipment and speakers

Two Audio Out terminals can be used to output an announcement from a transceiver via broadcasting equipment. Conversely, either of the two Audio In terminals can be used for effective broadcasting over the intercom system.

## ■ Dustproof & waterproof for outdoor use

Although normally used indoors, the WD-K10BS base station has sufficient dust- and drip-proof performance (IP54) to allow installation in sheltered outdoor areas such as roofed parking spaces.

## ■ Simple design for installation flexibility

The WD-K10BS can be installed virtually anywhere in a venue, including typical meeting areas, under the roof, or on a wall. The supplied mounting plate simplifies installation.

- Notes:
- Testing transceivers for IP67 dust- and water-proofing is performed at the developmental stage with the earphones connected and terminal covers all closed tightly; however, dust- and water-proofing are not guaranteed under all operating situations during actual use. Protective materials deteriorate with age but dust- and water-proofing should be effective for a one-year period with normal usage (when terminal and battery covers are in contact).
  - The body of the WD-K10TR/WD-K10PBS can be cleaned with ethanol; however, cleaning the radio should be conducted within the IP range.
  - The WD-K10TR or WD-K10PBS in transceiver mode can be used by registering it with a WD-K10PBS Portable Base or WD-K10BS Base Station. Actual registration of each transceiver is performed by an authorized dealer using dedicated software.
  - Up to 10 transceivers can be used simultaneously on a system.

# Simple to Deploy

As a stand-alone system, it could not be easier to get started

A stand-alone system simply combines a base station with several transceivers. You can choose between two types of base station – the WD-K10BS base station and the WD-K10PBS portable base. The former is suited for fixed installation indoors, while the latter operates on batteries and can be used where there is no external power supply available.

The WD-K10PBS portable base is recommended for its flexibility. It offers simultaneous 2-way communications for up to 10 transceivers. You can leave the mic switched on allowing you to join a conversation naturally at any time. With both stationary and portable base stations, users can be divided into groups, and both feature Listening mode.

## WD-K10BS Standalone Base Station

This model is designed to be installed on a semi-permanent basis. It features Audio In/Out terminals.

For retail stores, restaurants, etc.



## WD-K10PBS Portable Base

This model is intended to be as mobile as the transceivers. It supports simultaneous two-way conversations for up to 11 users (1 portable base + 10 transceivers).

For outdoor events, construction sites, etc.



# Coverage Expansion

Base-link system for daisy-chaining up to 4 base stations

The Base-link function enables daisy-chaining (using cables) up to 4 x WD-K10BS base stations to create a wider coverage area connecting more transceivers. This is particularly useful if, for example, there are transceiver users on 2 or more floors of a building, or spread out over an extensive factory site.

Note that a transceiver can only switch to a vacant/available channel. Also when being used for a simultaneous two-way conversation, the number of transceivers that can participate will depend on frequency congestion, the location of the base stations and transceivers, etc. Also, only the main base station can accept an audio input (Audio In terminals).

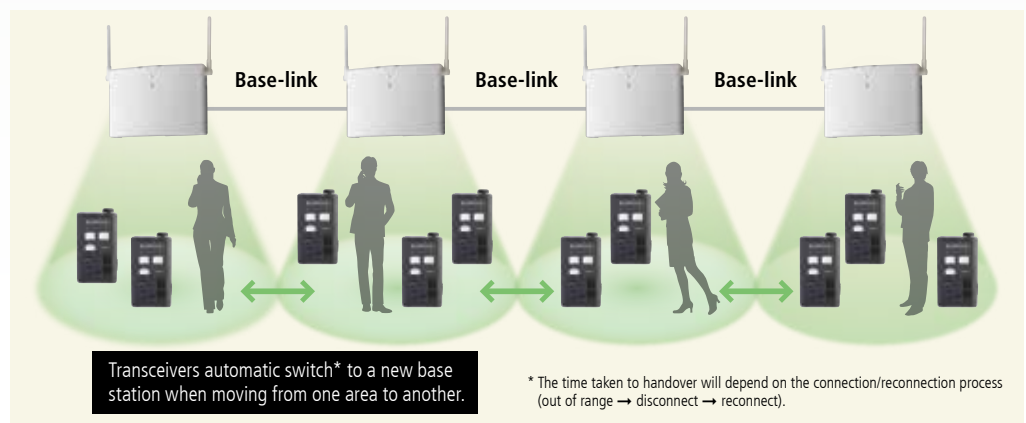

## Technical Information 1

### DECT 1.9GHZ

Transmissions on this frequency are hardly affected by the 2.4GHz ISM (industrial, scientific and medical) band used for Wi-Fi, microwave ovens, etc., or with the 5GHz band used for high-speed Wi-Fi. Operating at 1.9GHz means smooth uninterrupted communications. DECT offers high-quality audio for assured communications.

Note: This system is not compatible with DECT telephony systems.

### What is DECT?

- DECT (Digital Enhanced Cordless Telecommunications) is a world standard for digital cordless phone systems used mainly in Europe and the US.

# Efficient Operations

## Make the most of the Group function and Listening mode

### ■ Group function

It is often useful to divide up transceiver users into groups with different tasks, etc. so that conversations can be focused on only those concerned. Each transceiver can be registered with 2 or more groups for greater flexibility, and switching between groups is fast. A set of 4 Group LEDs indicate which group is current.

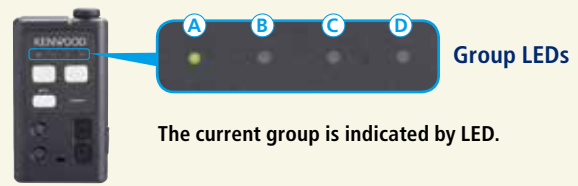

### ■ Listening mode (receiving only)

In addition to the transceivers operating in normal mode and able to participate in simultaneous two-way communications, it is also possible to register up to 64 transceivers in Listening mode. This is useful for relaying information to a larger number of people via intercom. If there is an unused channel available, one of these Listening mode transceivers can temporarily switch to normal mode, allowing the user to speak as well as listen. Switching from and back to Listening mode is smooth, taking approximately 1 second.\* This feature is useful if you want to increase the number of users who can participate in conversations.

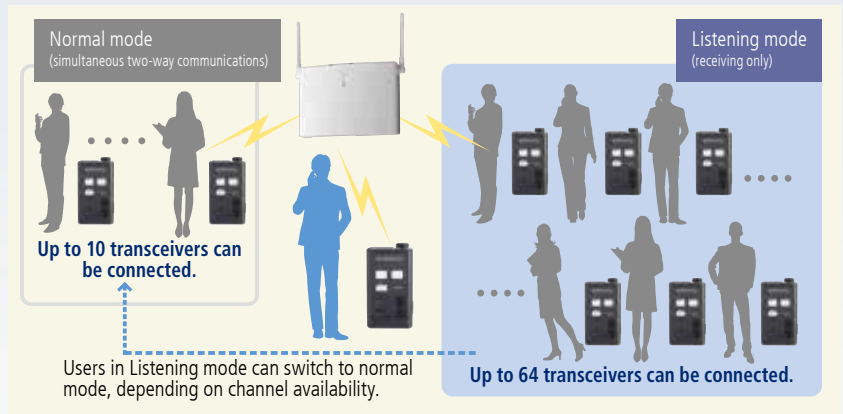

\* Switching from and back to Listening mode may take longer than 1 second, depending on frequency congestion, etc.

## System Configuration

### ■ Standard System

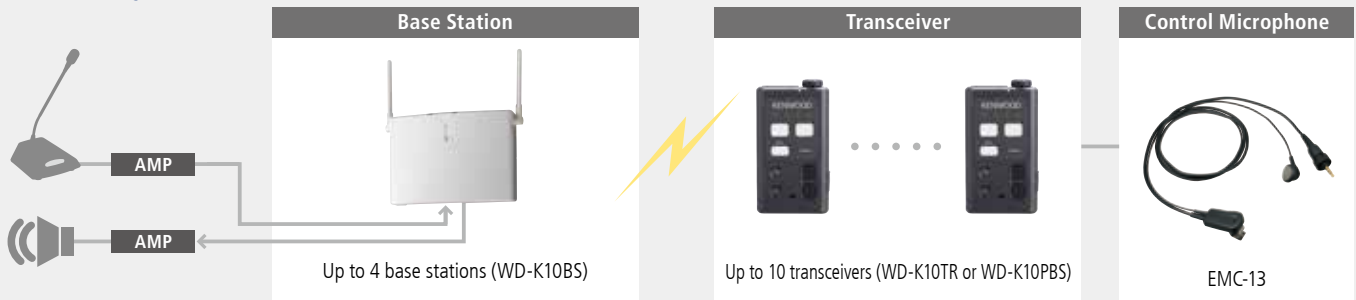

### ■ Mobile System



# Applications

Realising efficient communications for a variety of venues

## Case 1: Studio (single floor)

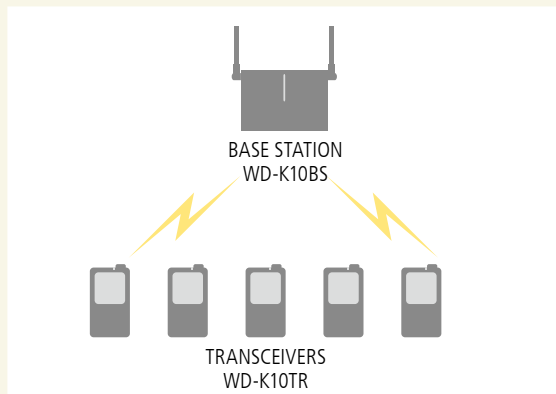

### Configurations

- Base Station WD-K10BS
- Transceiver WD-K10TR
- Charger KSC-48CR



## Case 2: Supermarket and Retail Park (Base-link to cover large areas and/or different locations)

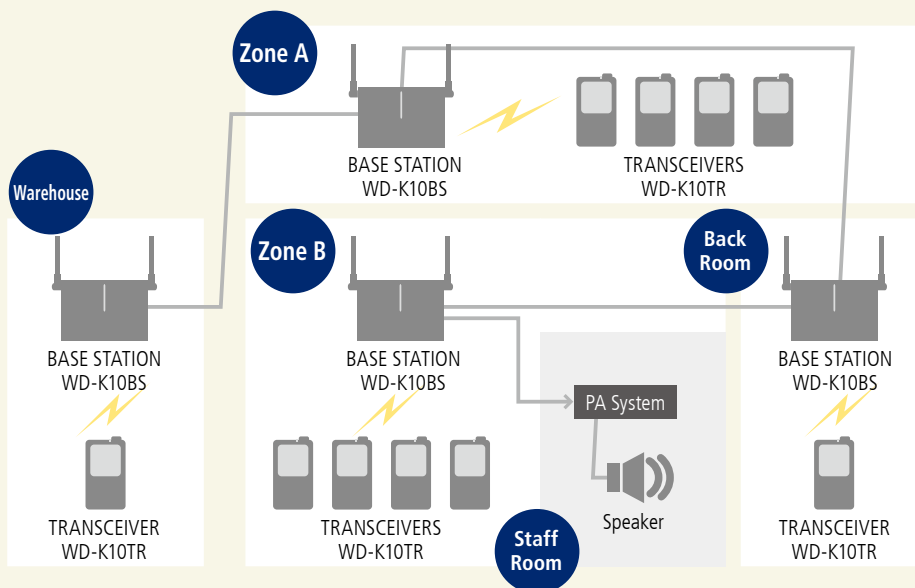

### Configurations

- Base Station WD-K10BS
- Transceiver WD-K10TR
- Charger KSC-48CR
- AC Adapter KSC-44ML



## Case 3: Outdoor Sports Event (Two-way radio contact)

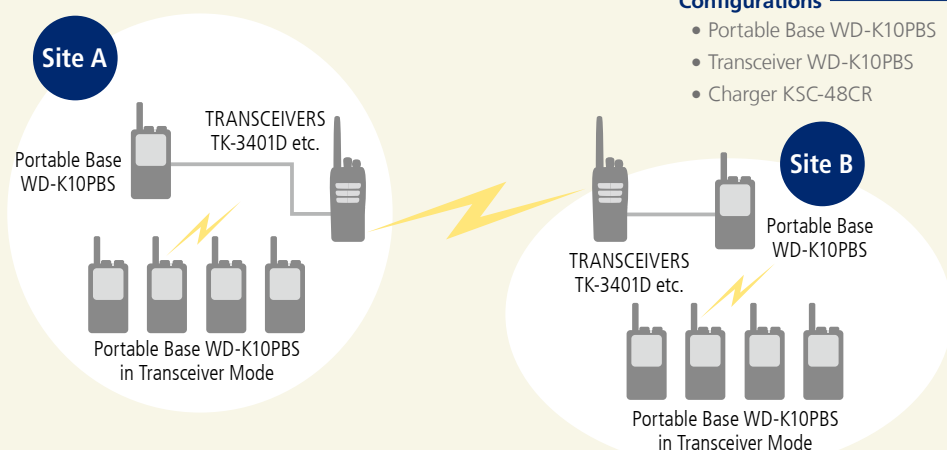

### Configurations

- Portable Base WD-K10PBS
- Transceiver WD-K10PBS
- Charger KSC-48CR
- AC Adapter KSC-44ML
- Interface Cable WD-RC100/RC50
- Transceiver TK-3401D, etc.



## OPTIONAL ACCESSORIES

### WD-UB110

Li-ion BATTERY PACK  
(3.7 V/1,880 mAh)  
for the WD-K10PBS



### KSC-48CR

CHARGER (DC5.5V)



Bundled use

### KSC-44ML

MULTIPLE AC ADAPTER  
for the KSC-48CR  
(E plug only)



### EMC-14

CLIP MICROPHONE WITH  
EARPHONE (EAR-HANGING)



### WD-RC100/WD-RC50

INTERFACE CABLE



WD-RC100: Universal Connector  
WD-RC50: 2-pin Connector

### WD-UB100

Li-ion BATTERY PACK  
(3.7 V/1,430 mAh)  
for the WD-K10TR



### KSC-44SL(B)

AC ADAPTER for the  
WD-K10BS/KSC-48CR



### EMC-13

CLIP MICROPHONE WITH  
EARPHONE (STD)



### KHS-37

HEADSET (EAR-HOOK)



## Specifications

	WD-K10TR	WD-K10PBS	WD-K10BS
Description	Transceiver	Portable base	Base station
Frequency Range	Europe: 1880 – 1900 MHz*		
System/Radio Format	DECT		
Operation Mode	Full Duplex		
Operating Temp. Range	-10°C to + 60°C		-10°C to + 50°C
Terminals	Microphone/Earphone mini jack, Micro-USB connector (Type B) for equipment setup using a PC.	Microphone/Earphone mini jack, Micro-USB connector (Type B) for equipment setup using a PC. Transceiver connection mini jack	Audio input and output x2 (stereo jack), Link terminal x2 (up/down link), External device control terminal x2, Micro-USB connector (Type B) for equipment setup using a PC, DC in terminal
Environmental Specifications**	IP55 and equivalent to IP67		IP54
Battery Type/Life (duty cycle: Tx 6", Rx 6", standby 48")	Li-ion/20hrs	Li-ion/8hrs when used as a portable base (w/ 4 terminals); 25hrs when used as a transceiver	—
Dimensions (W x H x D)	54 x 94 x 20.5 mm	54 x 94 x 23.5 mm	196 x 136 x 50 mm
Weight (Net, approx.)	118 g	135 g	995 g

\*These units are transceivers that use the full 1,881.792 to 1,897.344 MHz channels.

\*\* Connector covers have to be connected to the transceiver to obtain the dust- and water-proofing performances stated in this specifications.

## External Dimensions (unit: mm)

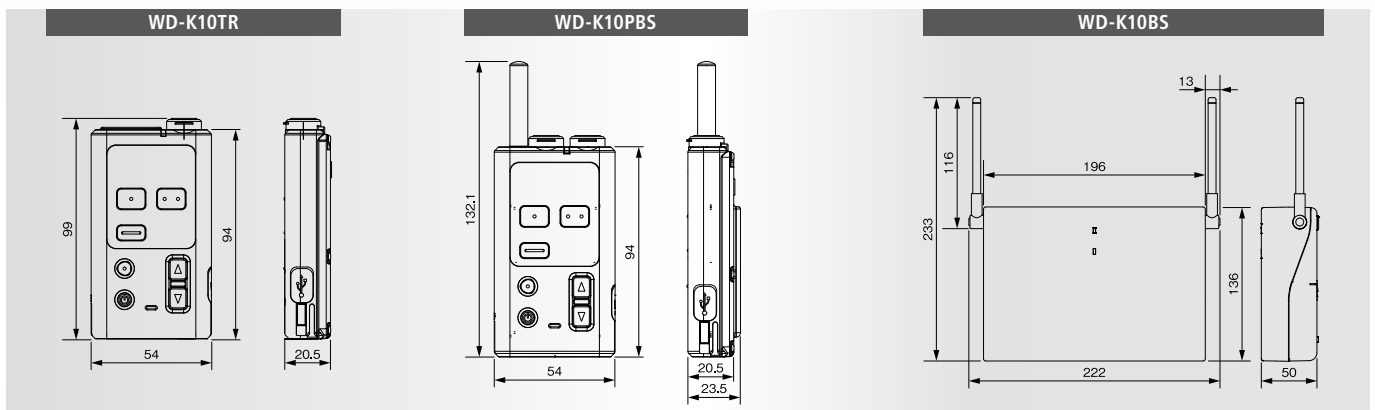

## Typical Transceiver Ranges\*: Approx. 30m to 300m.

\* The range may be narrower for the WD-K10TR over WD-K10PBS in transceiver mode. Also, the range may be narrower when the WD-K10PBS is used as the base unit over WD-K10BS. These ranges assume open, unobstructed spaces. Actual ranges will depend on such factors as the location of the base station, building materials, nearby electrical equipment, etc.

# KENWOOD

Notes: ● These radios are designed based on the regulations under which each country has determined to not interfere with other equipment; however, it is recommended to test and measure for interference before using the radio. If there is any possibility that the device could cause adverse interference to other wireless stations, discontinue use and consult your local authorized KENWOOD dealer or the retail outlet where the transceiver was purchased for details concerning interference prevention such as installing a partition. ● Careful testing and verification in advance are necessary when using the radio in close proximity to medical and healthcare equipment. ● The battery can be replaced when necessary by purchasing a new optional battery specifically designed for the product.  
● Details and timing of firmware and software updates are subject to change without notice. Specifications are measured according to applicable standards, and subject to change without notice, due to advancements in technology.  
● All product names referenced herein are trademarks or registered trademarks of their respective manufacturers.

## JVCKENWOOD U.K. Limited

12 Priestley Way, London NW2 7BA, United Kingdom

[www.kenwoodcommunications.co.uk](http://www.kenwoodcommunications.co.uk)

